

三柱塞泵 K 4500

Triplex Plunger Pump

P 1-1

01.01.2018

- 流量基于100%的容积效率和20°C的环境温度
- 最小入口压力取决于流体介质
- 速度范围10-100%取决于连杆力
- 喷射润滑齿轮
- V型带驱动
- 适用API 674标准
- 根据要求，可以使用特殊介质，例如海水，乙二醇，甲醇，油等

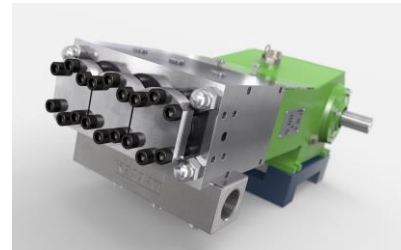

- Flow rate is based on 100% volumetric efficiency and 20°C ambient temperature
- min. inlet pressure depending on fluid medium
- Speed range 10-100% depending on rod force
- Gear with splash lubrication
- V-Belt drive
- Also available to API 674
- Special medium such as sea water, glycol, methanol, oils, etc. on request



$n_{nom} = 650 \text{ 1/min}$		p max. bar @ kW				Kopftyp / Head type		
Typ / Type	l/min	22 kW	30 kW	37 kW	45 kW	A	M	MC
K 4512	11	1000	1400	1700	2100	1		
K 4514	15	750	1020	1260	1530	1		
K 4516	20	575	780	960	1170	1		
K 4518	25	485	665	805	940	1		H
K 4520	31	390	535	660	760	1		H
K 4522	37	330	450	555	630	1		H
K 4524	44	275	375	465	530	1		H
K 4526	52	235	320	395	450	1		H
K 4528	60	200	275	340	390	1		H
K 4530	69	175	230	285	340	1	1	H
K 4532	78	155	210	260	295	1	1	1
K 4536	99	115	155	195	235		1	1
K 4540	122	95	125	160	190		1	1
K 4545	155	75	105	125	150			1
K 4550	191	60	85	105	120			1
K 4555	232	50	70	85	100			1

API 674 = max. 450 1/min

= Ultra High Pressure UHP

尺寸图 K 4500
Dimension drawing

~ 195 kg P 1-2
01.04.2018

Typ A
Type A

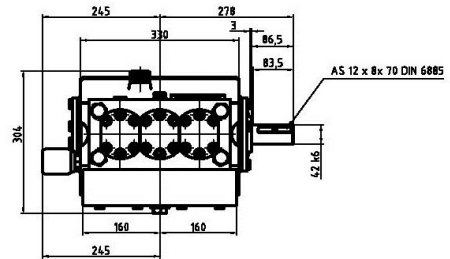
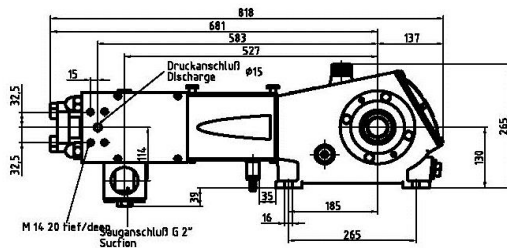

Typ M
Type M

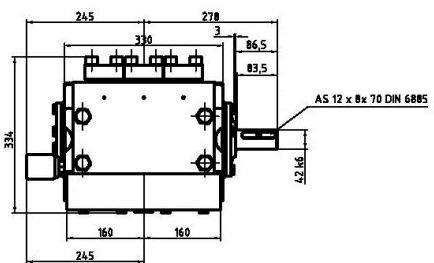
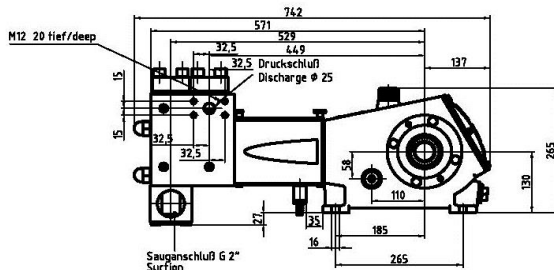

Typ MC
Type MC

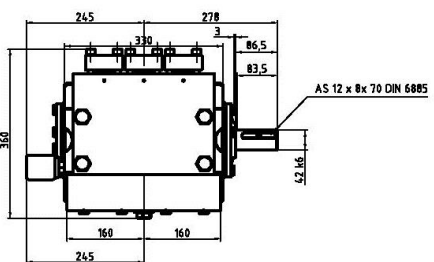
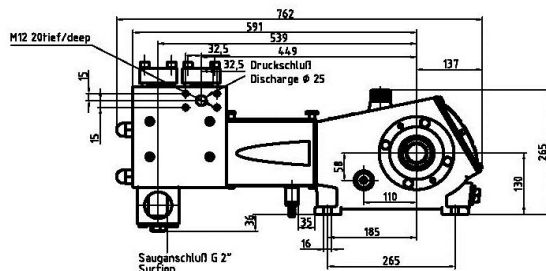

Typ MCH
Type MCH

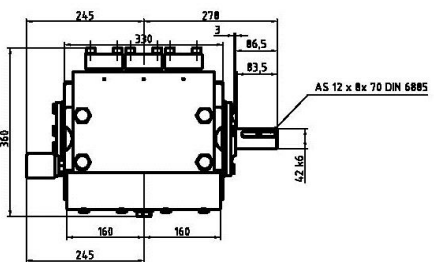
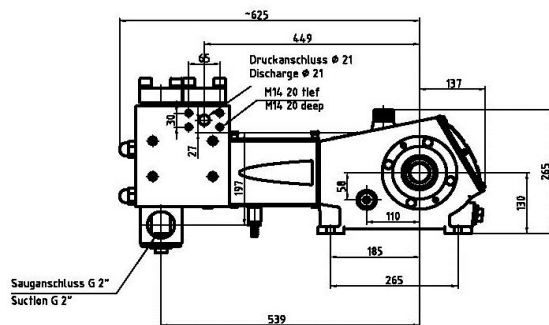

Typ A
Type A
 ≈ 1500 bar

